

Analytic comparison of using FFT and wavelet in IEEE 802.11.a WLAN based OFDM technique

Habab Habib Alshammary, Abdel-Rahman Al-Qawasmi

Abstract Modulation techniques play a significant role in minimizing the effect of noise produced by noisy channels, especially thermal noise produced due the heat effect in electronic communication systems. The effect of noise has a significant value in wireless communication systems and can affect the performance of systems and be increasing the probability of error. This increasing of the probability of error will be over some acceptable values due the me\multiplexing technique used which will force the system to decrease the needed data rate. OFDM meets requirements of high data rates of mobile wireless communications; the OFDM technology is to be an essential technique for achieving the high data capacity and spectral efficiency requirements for wireless communication systems. In this paper an investigation into wavelet and Fast Fourier Transform (FFT) and their effect on WLAN IEEE.802.11.a system that implements Orthogonal Frequency Division Multiplexing OFDM analyzed the effect of AWGN using different modulation techniques parameters that simulated to study the performance of the proposed system such as BPSK, DPSK, QPSK, DQPSDK QAM16 and QAM64. Results extracted in simulation part presents a sufficient privilege for DWT-OFDM pair.

Index Terms— OFDM, wavelet, IFFT, IEEE 802.11, WLAN.

I. INTRODUCTION

The Fast Fourier Transform (FFT) is an algorithm that Scientific use to compute the discrete Fourier transform faster than can do discrete Fourier transform or other algorithms [1].

The FFT is important in it has a central place in different applications such as image and signal processing due to its working in the frequency domain.

The real equivalent version of DFT Real and Imaginary) is [2].

This work was is submitted in 28\3\2016 and supported in part by the Department of Electrical Engineering College of Engineering, Majmaah University, Majmaah 11952, Saudi Arabia.

A. Al-Qawasmi is with the Majmaah University, Riyadh province, KSA (a.alqawasmi@mu.edu.sa).

Habab Habib Alshammary, Msc. E-learning management

$$\tilde{C}_n^R = \sum_{k=0}^{N-1} \{f^R(k)\cos(\theta) + f^I(k)\sin(\theta)\}$$

(1)

$$\tilde{C}_n^I = \sum_{k=0}^{N-1} \{f^I(k)\cos(\theta) - f^R(k)\sin(\theta)\}$$
 (2)

M. Rahman mentioned in his book [3], it is better to divide the transform into N/2 equal parts at each step. This algorithm is known as a Cooley-Turkey algorithm that limits the power to power-of-two sizes. In this case, the number of complex multiplications and additions can be reduced, and the transformation will be fast.

The Discrete Wavelet Transform (DWT) deals with time-domain dependent functions of time and it can be written as [4]:

$$S_n^m = \int_{-\infty}^{+\infty} S(t)2^{m/2}\psi(2^m t - n)dt$$
 (3)

The Wavelet function is:

$$S(t) = \sum_{m=-\infty}^{\infty} \sum_{n=-\infty}^{\infty} S_n^m 2^{m/2} \psi(2^m t - n) \quad (4)$$

Two scaling functions used with Wavelet transform [4]:

$$a_n^{m+1} = \int_{-\infty}^{\infty} S(t) \phi_n^{m+1}(t) dt \quad (5)$$

and

$$A_{m+1} S(t) = \sum_n a_n^{m+1} \phi_n^{m+1}(t) \quad (6)$$

Practical signals are limited in frequency and limited in time [8]. The frequency analysis in wavelet transform is performed using low frequency while the analysis is performed by applying high-frequency versions of the mother wavelet.

Some issues are important in designing wavelet functions: Smoothness, Approximation accuracy and Size of the support of wavelets

The principal difference between FFT and DWT is that Fourier transform localized in frequency whereas Wavelet transform is localized in both frequency and time. Also, Wavelets often give a better signal representation using Multiresolution analysis, with balanced resolution at any time and frequency.

Orthogonal Frequency Division Multiplexing (OFDM) is a conventional form where all sub-carriers are orthogonal to each other. Due to the minimum frequency distance between carriers, OFDM provides high data rate, high resistance to frequency selective fading and reasonable complexity and cost.

The orthogonality requires that the sub-carrier spacing is:

$$\Delta f = \frac{k}{T_U} \text{ Hertz} \quad (7)$$

where T_U seconds is the symbol duration and k is a positive integer.

An OFDM signal is a sum of different subcarriers that are modulated by using Phase Shift Keying (PSK) or Quadrature Amplitude Modulation (QAM). The symbol can be written as:

$$s(t) = \text{Re} \left\{ \sum_{i=-N_s/2}^{N_s/2} d_{i+N_s/2} \exp(j2\pi(f_c - \frac{i+0.5}{T})(t-t_s)) \right\}, t_s \leq t \leq t_s + T \quad (8)$$

$$s(t) = 0, t < t_s \text{ and } t > t_s + T$$

OFDM signals are typically produced digitally due to the challenge of creating huge banks of phase lock oscillators and receivers in the analog domain. Figure 1 shows the block diagram of a typical OFDM transceiver [5].

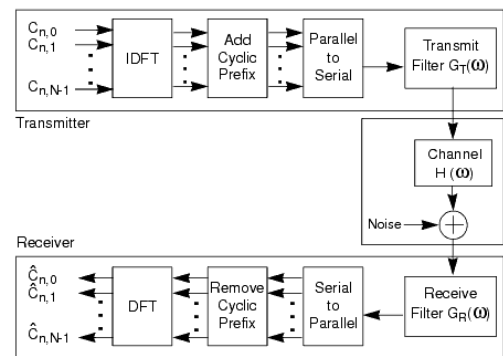

Fig. 1. Block diagram showing a basic OFDM transceiver

Wireless Local Area Networks (WLAN) becomes familiar and preferred network access among users. The first of the IEEE Workshops on WLAN was held in 1991 [6]. At that time, initial wireless LAN products had just appeared on the market, and the IEEE 802.11 committee had just begun its activities to develop a standard for WLANs [6].

Wireless LAN provides more flexibility than traditional wired local area networks standards and support data rate ranging from 1-2Mbps to 11Mbps and 54Mbps depending on the specifications used.

The IEEE 802.11 committee is responsible for WLAN standards including 802.11, 802.11a, 802.11g and 802.11b together with other standards that define Quality of Service (QoS) and Security for WLAN [7-8].

Primary types of equipment used in WLAN system is listed in [9]. Each 802.11a/b/g device can operate in one of four possible modes [8]. Following table is a summary of the 802.11 network standards.

In this paper research, the IEEE 802.11(a) standard will be used. The IEEE 802.11a is an Orthogonal Frequency Division Multiplexing (OFDM) system very comparable to the Asymmetrical Digital Subscriber Loop (ADSL) Discrete Multi-Tone (DMT) modems sending different subcarriers in parallel using the Inverse Fast Fourier Transform (IFFT) and receiving those subcarriers utilizing the Fast Fourier Transform (FFT). In the IEEE 802.11a

standard, the transmission medium is wireless, and the operating frequency band is 5 GHz [10-11].

The IEEE 802.11a standard system utilizes 52 subcarriers that are modulated using binary or quadrature phase-shift keying (BPSK/QPSK), 16 Quadrature Amplitude Modulation (QAM), or 64 QAM. The pilot tones are used at the receiver to estimate any residual phase error. Forward Error Correction (FEC) coding (convolutional coding) is used with a coding rate of 1/2, 2/3, or 3/4.

The wavelet based OFDM modulator and demodulator used is shown in Figure 2, the overall system of OFDM is the same as in Figure 1; the only difference is in the OFDM modulator and demodulator.

The processes of the S/P converter, the signal demapper and the insertion of training sequence are the same as in the system of FFTOFDM.

Also, the zeros will be added as in the FFT-OFDM model. After that the inverse discrete wavelet transform (IDWT) will be applied to the signal. The main and important difference between FFT based OFDM and DWT based OFDM is that the wavelet based OFDM will not add a cyclic prefix to OFDM symbol. Therefore, the data rates in wavelet based OFDM can surpass those of the FFT implementation. After that, the P/S converter will convert the OFDM symbol to its serial version and will be sent through the channel. At the receiver, the S/P converts the OFDM symbol to parallel version.

Also, the zero pads will be removed, and the other operations of the channel estimation, channel compensation, signal demapper and P/S will be performed in a similar manner to that of the FFT based OFDM.

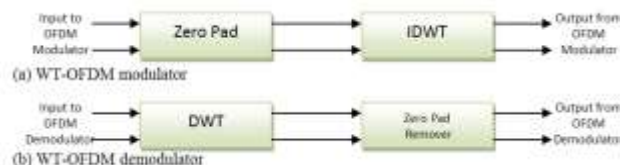

Fig. 2. WT-OFDM modem System

IFFT and the FFT in the conventional system are replaced by the discrete wavelet Transform Wavelet Transform (DW) and the methods of the S/P converter, the signal demapper and the insertion of training sequence are the same as in the OFDM system based FFT.

Also, the zeros will be added as in the OFDM model based FFT. After that, the DWT will be applied to the signal. The main and significant difference between OFDM based FFT and the OFDM-based DWT is that the OFDM model based wavelet transforms will not add a cyclic prefix to the OFDM symbols. Therefore, the data rates in this

system can surpass those of the FFT implementation model. After that the P/S converter will convert the OFDM symbol to its serial version and the signals (data and training) will be sent through the channel to the receiver. At the receiver, the S/P converts the OFDM symbol to the parallel version, then, the DW will be applied to the received symbols. Also, the zero pads will be removed, and the other operations of the channel estimation, channel compensation, signal demapper and P/S will be performed in a similar manner to that of the OFDM-based FFT.

The wavelet transform divides the signal into the approximation coefficients and detail coefficients as shown above. In a DWT based system, the wavelet transform blocks, inverse discrete wavelet transform (IDWT) and discrete wavelet transform (DWT) replace the IFFT and FFT of FFT-OFDM system in modulation and demodulation processes [12].

One of the advantages of applying wavelet transform is that due to the overlapping type of wavelet properties, the wavelet based OFDM does not need the cyclic prefix to deal with delay spreads of the channel. As a result, it has higher spectral containment than that of Fourier-based OFDM [13]. The input information is processed as per FFT-OFDM. However, the variation is that the system does not require CP to be added to the OFDM symbol. The output of the inverse discrete wavelet transform (IDWT) can be represented as [14]:

$$d(k) = \sum_{m=0}^{\infty} \sum_{n=0}^{\infty} D_m^n 2^{m/2} \Psi(2^m - n) \quad (9)$$

where S_m^n are the wavelet coefficients and $\Psi(t)$ is the wavelet function with compressed factor m times and shifted n times for each subscriber (number $k, 0 \leq k \leq N-1$). The wavelet coefficients are the representation of signals in scale and position or time. X_m at the receiver side, the process is inverted. The output of DWT is

$$D_m^n = \sum_k^{N-1} d(k) 2^{m/2} \Psi(2^m - n) \quad (10)$$

Multiresolution analysis of wavelet theory allows to represent wavelets and scaling functions by great and low pass filters (HPF and LPF) sequentially with impulse responses $h[m]$ and $g[m]$. Therefore, the wavelet transform can be easily implemented using discrete time filters.

The OFDM performed by using IFFT's and FFT's have some difficulties. The OFDM suffers from



•ISI (intersymbol interference) –This is frequently taken care of by using an adding a cyclic prefix larger than the channel length but this may not always be possible. This process occurs due to loss of orthogonality due to channel effects.

• Time and Frequency Synchronization [15]. The OFDM needs time and frequency synchronization to get a low bit error rate.

• Carrier Frequency Offset- The offset between the carrier frequency and the frequency of the local oscillator also creates a significant bit error rate.

Due to these problems we want to look at another sort of modulation to generate the carrier. One of these is the wavelet transform. Several authors suggest the wavelet transform; it has a higher degree of side lobe suppression and the loss of orthogonality lead to lesser ISI and ICI. In Wavelet OFDM, the FFT and IFFT are replaced by DWT and IDWT sequentially. For the Wavelet transform, we observe that from the time-frequency plot that the first Wavelet transform gives minor flexibility than the wavelet packet transform. For the wavelet packet transform, we can construct an algorithm to do the decomposition such that the effect due to the noise [16].

The above fig dispenses the case; the dark lines represent the noise. The top-left corner provides the usual wavelet decomposition. The bottom-left presents a carrier with no decomposition. The top-right shows a symmetrical tree structure while the bottom-right shows the select subcarrier decomposition. A subcarrier compares to a rectangle in the time-frequency timing. Thus, if the maximum resolution is defined, we can have the same number of subcarrier regardless of the tree structure.

| Paste Special | Picture (with “float over text” unchecked).

II. DISCUSSION AND PROBLEM FORMULATION

There are different applications of DWT. It has a wide application in Digital Signal Processing (DSP), Image Processing and Identification techniques. It can be considered as a powerful tool for various analyzes with many advantages as mentioned before.

In analysis part, we will introduce a simulation plan and theoretical analyzes to show the IEEE.802.11.a WLAN performance due to AWGN and multipath effects.

In simulation part, a simulation Matlab programs will be simulated and presented to show the performance of FFT-OFDM and DWT-OFDM on IEEE.802.11.a WLAN.

The system model for FFT-based OFDM will not be discussed in detail as it is well known in the literature. Thus, we merely present a brief description of it. The data d_k is first being processed by a constellation mapping. M-ary QAM modulator is utilized for this work to map the raw binary data to appropriate QAM symbols. These symbols are then inputted into the IFFT block. This includes taking N parallel streams of QAM symbols (N being the number of sub-carriers used in the transmission of the data) and performing an IFFT operation on this parallel stream [17].

A. DWT-OFDM IEEE.802.11a WLAN System:

In DFT-based OFDM, a CP is combined to eliminate ISI. However, this can minimize bandwidth efficiency greatly. Discrete alternative programs for replacing ID spectral containment of the channels is better since it do DWT-based OFDM an advantage of bandwidth efficiency.

The overall system of OFDM based discrete wavelet transforms that will use in the simulation is the same as FFT-OFDM. The IFFT and the FFT in the conventional system are replaced by the IDWT and the DWT blocks. The processes of the S/P converter, the signal demapper and the insertion of training sequence are the equivalent as in the OFDM system based FFT [18].

Also, the zeros will be added as in the OFDM model based FFT. After that, the IDWT will be applied to the signal. The main and important difference between OFDM based FFT and the OFDM-based DWT or is that the OFDM model based wavelet transform will not add a cyclic prefix to the OFDM symbols. Therefore, the data rates in this system can surpass those of the FFT implementation model. After that the P/S converter will convert the OFDM symbol to its serial version and the signals (data and training) will be sent through the channel to the receiver. At the receiver, the S/P converts the OFDM symbol to the parallel version, then, the DWT will be applied to the received symbols. Also, the zero pads will be removed, and the other operations of the channel estimation, channel compensation, signal demapper and P/S will be performed in a comparable manner to that of the OFDM-based FFT [18-20]. The training sequence will be used to estimate the channel frequency response [21]. The block diagram of OFDM system based on DWT is shown in Figure 3

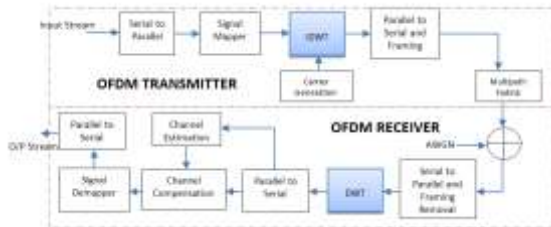

Fig. 3. The block diagram of OFDM system based on DWT

B. Discussion:

The simulation process contains two main approaches: The first approach based on BER performance analysis between FFT-OFDM and DWT-OFDM depending on three main sources of disturbances or distortion: AWGN, multipath effects and delay spread.

The second simulation approach concentrated on the use of different wavelet functions and showed the effect of their implementation on the BER performance of DWT-OFDM system employed in IEEE 802.11.a

There several wavelet families: Daubechies, Haar Coiflets, Symlets. For an orthogonal wavelet, in the multiresolution structure, we start with the scaling function ϕ and the wavelet function ψ . One of the direct relations is the twin-scale relation [22]:

$$\frac{1}{2} \phi\left(\frac{x}{2}\right) = \sum_{n \in \mathbb{Z}} \omega_n \phi(x-n) \quad (11)$$

All the filters utilized in DWT and IDWT are intimately related to the sequence $(\omega_n)_{n \in \mathbb{Z}}$. Clearly if ϕ is compactly installed, the sequence (in) is finite and can be viewed as an FIR filter. The scaling filter W is a low-pass. From filter W, we determine four FIR filters, of length $2N$ and norm 1, organized as follows: decomposition low-Pass, decomposition high-Pass, reconstruction low-pass and reconstruction high-pass [22].

For FFT-OFDM Before any receiver algorithms can be employed, the timing must first be improved; that is, the system clock at the receiver must match synchronized with the transmitter's clock, while taking into account the propagation delay of the channel. Since OFDM is a frequency domain modulation technique, it is required to

have accurate estimates of the frequency offset, produced by oscillator instability, at the receiver. The accuracy of the channel estimation algorithm is also crucial to the overall system's performance. The phase correction algorithm uses the pilot subcarriers to correct the rotation of the OFDM symbols. This rotation was introduced by the residual frequency offset of the carriers.

The equalization is a necessary step to recover the distorted signal, due to multipath fading. Then the signal is demodulated using a soft decision demodulator, that is, the demodulated bits retain additional information about the reliability of the decision. To include this extra information, the soft bits have various values: a large absolute value of the initial bit and a small value for the second bit. In our simulation, the sign of the soft conclusion indicates a 0 or 1 bit. The absolute value of each soft choice is the distance to the decision boundary. This additional information can significantly improve the performance of channel coding schemes.

C. Performance of FFT-OFDM and DWT-OFDM based IEEE.802.11.a WLAN System

Various transmission modes are defined in IEEE 802.11 a/b/g WLAN standards. A very few transmission modes are considering for IEEE 802.11 a/b/g in physical layer parameters and wireless channel characteristics. In this thesis, we evaluated the performance of available transmission modes in IEEE 802.11a [1]. Nevertheless, the performance analysis can be done straightforward using the evaluation of IEEE 802.11a. The performance of transmission modes is estimated by computing the probability of Bit Error Rate (BER) versus the Signal Noise Ratio (SNR) following the often used three wireless channel models (AWGN, Rayleigh and Rician). We examine the data modulation and data rate to investigate the performance that is BER vs. SNR. We also examine multipath received signals. The simulation results had confirmed the performance of transmission modes under several channel models and the number of antennas. Based on simulation results, we observed that some transmission methods are not efficient in IEEE 802.11a. The evaluation of performance verifies the increase in the coverage area of the physical layer in the 802.11a WLAN devices [23].

The program contains two main parts:

Part 1: Simulation of FFT-OFDM IEEE.802.11.a WLAN system with specific input parameters shown in table 4. This part contains four subprograms simulating the effect of AWGN, multipath effects, Doppler Effect and delay spread on the BER. In this part, four modulation techniques used: BPSK, DPSK, 16-QAM and 64-QAM

Part 2: Simulation of DWT-OFDM IEEE.802.11.a WLAN with specific parameters and performance analysis as simulated for FFT-OFDM. The difference here is the using of different Wavelet signals to study different results depending on the signal used.

D. BER performance of FFT-OFDM IEEE.802.11.a WLAN

The BER performance of FFT- OFDM is compared with Discrete DWT Orthogonal Frequency Division Multiplexing system (DWT- OFDM) using BPSK as a modulation technique over AWGN and Multipath Rayleigh Fading Environment.

Using MATLAB simulation, we can implement an OFDM transmission. Using the simulation we can easily modify the values of S/N ratio, and then we can investigate the results of each transmission and see how the BER is changed.

In this paper, OFDM system is implemented using MATLAB simulation, where each block of OFDM is simulated in scripts file. Figure 6 shows the block diagram of the OFDM. DWT-OFDM is obtained by replacing IFFT at transmitter and FFT at the receiver by IDWT and DWT respectively. We have recognized AWGN and Multipath Rayleigh Fading Channels for comparing BER of FFT-based OFDM and DWT-based OFDM. The following OFDM system parameters are examined for the simulation:

E. Performance of FFT-OFDM based WLAN IEEE.802.11.a Affected by AWGN:

In this simulation we used the Matlab program to simulate the effect of AWGN on the performance of WLAN system using BPSK, QPSK, 16-QAM, and 64-QAM.

TABLE I
SIMULATION OFDM SYSTEM MAIN PARAMETERS

Parameters	Value
IFFT and FFT Size	64-point
IDWT and DWT Size	64-point
No. Of data sub carrier	52
Data symbol duration (Td)	1μs
Cyclic prefix duration (Tcp)	16
Digital Modulation	BPSK, QPSK, 16-QAM and 64-QAM
FEC codes	CRC, Convolutional
Convolutional Code Rate	1/2
Interleaver Size	35x1
SNR Range (AWGN)	1-10 dB
Channels	AWGN, Rayleigh, Rician
OFDM Block size	8
Cyclic Prefix Length	1
Doppler shift	20 Hz

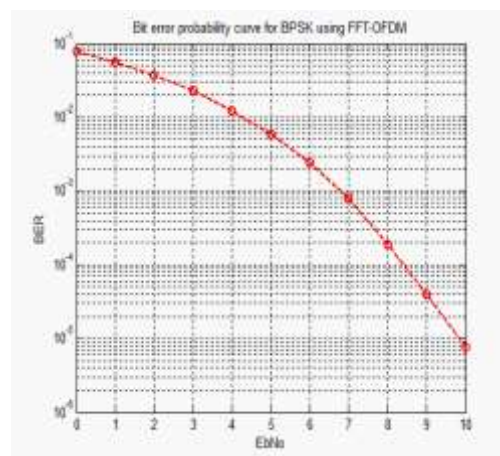

(a)

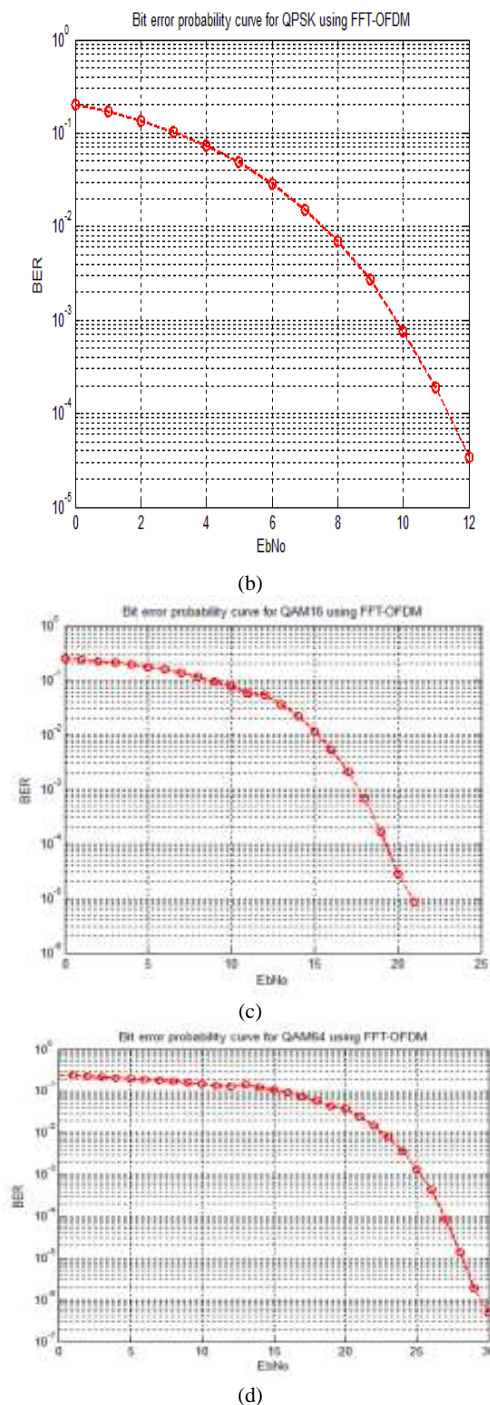

Fig. 4. BER of FFT-OFDM WLAN IEEE.802.11 a (a) BPSK, (b) QPSK, (c) 16QAM and (d) 64QAM

Figure 4 shows that that the effect of AWGN on OFDM systems is not significant comparing to the effect of multipath effects and synchronization. Figure 6 shows that

BPSK FFT-OFDM system has the best noise immunity compared to other modulation techniques.

As an additional experiment, different codes such as Kasami, Bernoulli and Gold codes are used as input data. Results shown in figure 5 shows that the effect is minor. The FFT-OFDM system processes the binary data in series fashion at before S/P.

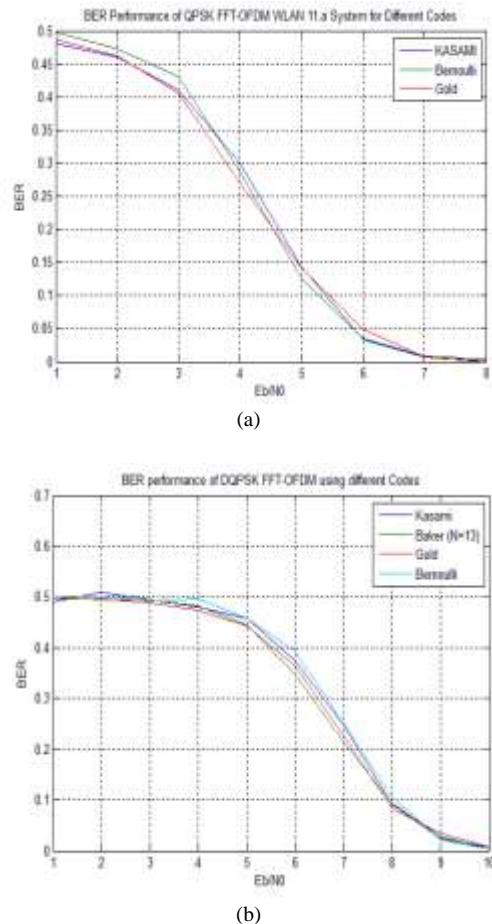
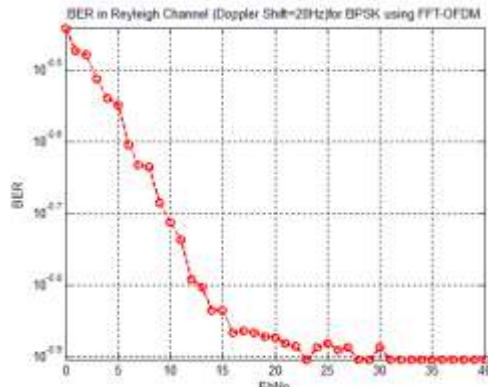
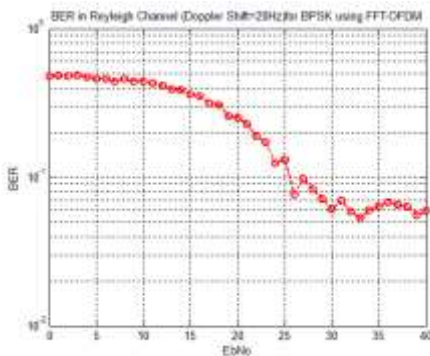

Fig. 5. BER of FFT-OFDM WLAN IEEE.802.11 a, for various Codes: (a)QPSK (b)DQPSK

F. Performance of FFT-OFDM based WLAN IEEE.802.11.a Affected by Rayleigh multipath



(a)



(b)

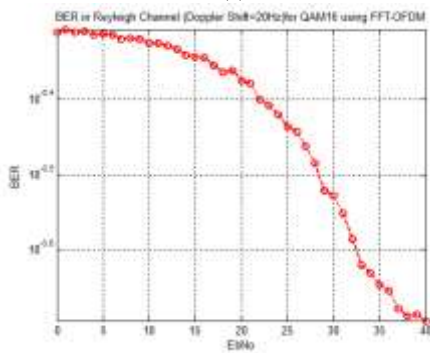

(c)

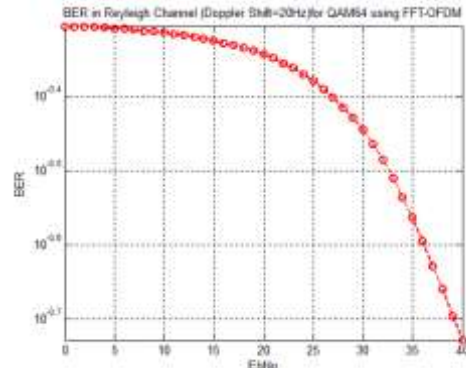

(d)

Fig. 6. BER of FFT-OFDM WLAN IEEE.802.11 a with a Rayleigh Channel

a) BPSK, (b) QPSK, (c) QAM16 and (d) QAM64

To check the performance of the FFT-OFDM WLAN IEEE.802.11.a System through Rayleigh channel considering the effect of AWGN, a Simulink Matlab program is used as shown in figure 6.

In this simulation, it is observed that the BPSK and QPSK modulation techniques demonstrate better performance in contrast to others. On the other hand, 16QAM and 64QAM show more stability in channel behavior. In this case, the effect Doppler is taken 20 Hz and symbol duration equals to 1 μ s.

G. Performance of FFT-OFDM based WLAN IEEE.802.11.a Affected by Rician multipath:

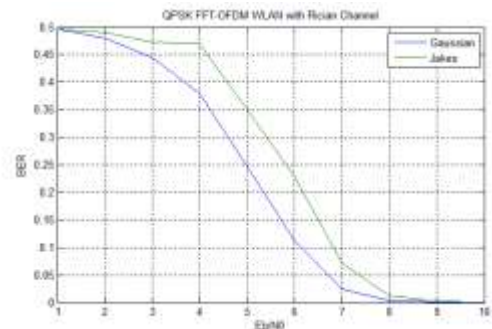

Fig. 7. Effect of Multipath Rician Channel on WLAN FFT-OFDM

Figure 7 represents the effect of Rician channel on the FFT-OFDM based WLAN IEEE 802.11.a. It's clearly shown that Jakes effect is less than Gaussian effect.

Next simulation will concentrate on the effect of AWGN and multipath effects on DWT-OFDM based WLAN.

H. BER performance of DWT-OFDM IEEE.802.11.a WLAN

In Figure 8 the BER of DWT-OFDM performance and different spectrums are represented. Here, BPSK modulation is used and Daubechies with order 2.

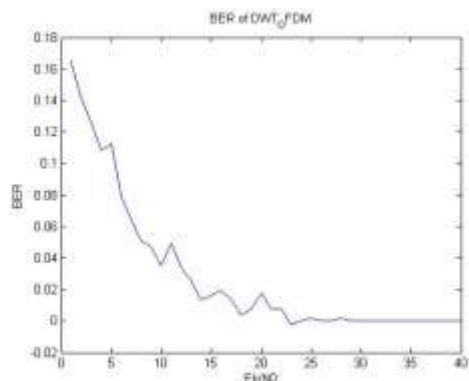

(a)

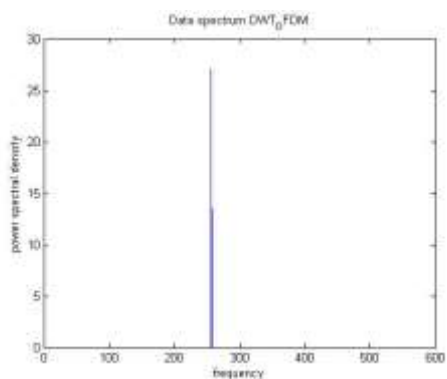

(b)

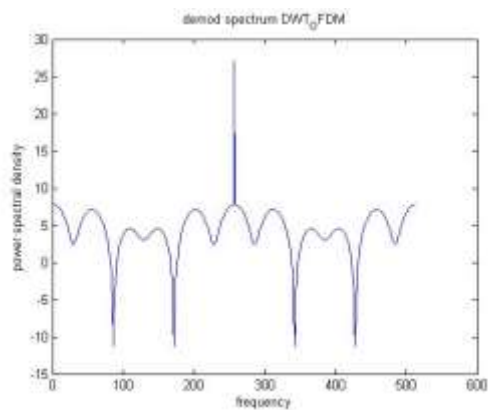

(c)

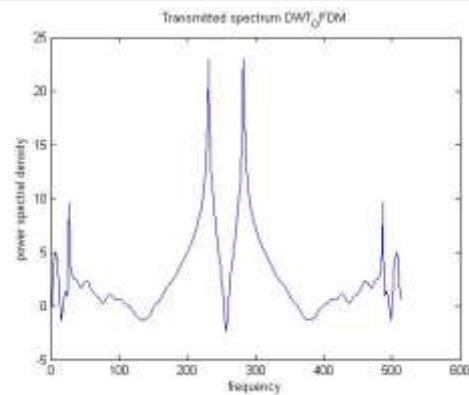

(d)

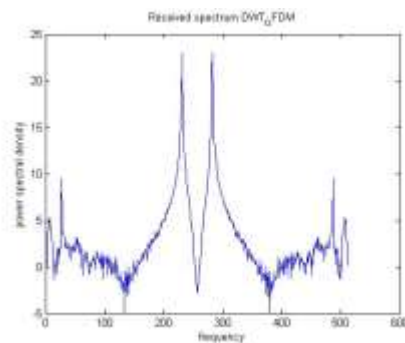

(e)

Fig. 8. the BER of DWT-OFDM and spectrums in different location in DWT-OFDM System (Daubechies with order 2).

In Figure 9 the BER of DWT-OFDM performance for BPSK modulation and Haar wavelet.

Comparing BER in figure 8 (a) figure 9 the BER performance is very close. This result can be explained due to the same wavelet family (orthogonal) signals.

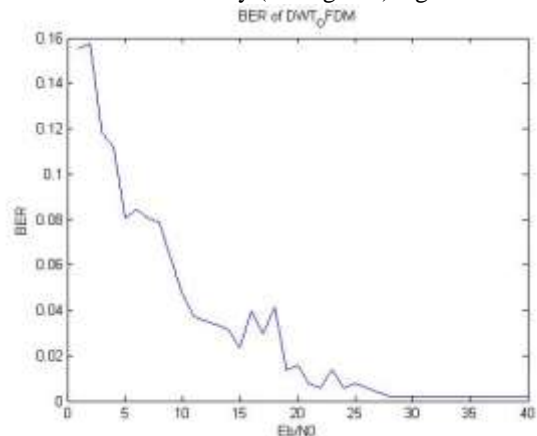

Fig. 9. the BER of DWT-OFDM performance for BPSK modulation and Haar wavelet



III. CONCLUSION

In this paper an OFDM IEEE.802.11.a wireless network is investigated for Discrete wavelet (DWT) and Fast Fourier Transform (FFT) under the effect of AWGN using different modulation techniques parameters that simulated to study the performance of the proposed system such as BPSK, DPSK, QPSK, DQPSK QAM16 and QAM64. Results extracted in simulation part presents a good privilege for DWT-OFDM pair

REFERENCES

- [1] E. O. Brigham, R. E. "The fast Fourier transforms ", Morrow LTV Electro systems, Inc., IEEE spectrum DECEMBER 1967
- [2] Duc Nguyen, "Discrete Fourier Transform, Textbook notes on discrete Fourier transform ", Date May 1, 2012.
- [3] M. Rahman, "Applications of Fourier Transforms to Generalized Functions", WIT Press, Jan 1, 2011
- [4] C.S. Burrus, R.A. Gopinath, H. Guo, (1997) Introduction to Wavelets and Wavelet Transforms, a Primer, Prentice Hall Inc.
- [5] Neha Pathak, "OFDM (Orthogonal Frequency Division Multiplexing) SIMULATION USING MATLAB", International Journal of Engineering Research & Technology (IJERT), Vol. 1 Issue 6, August – 2012, ISSN: 2278-018
- [6] The Second IEEE Workshop on Wireless LANS: Summary, Worcester Polytechnic Institute. Available online: <http://www.cwins.wpi.edu/wlans96/scripts/summary.html>. 2008, March 16.
- [7] Erina Ferro and Francesco Potorti, Bluetooth and WI-FI Wireless Protocols: A Survey and Comparison. IEEE Wireless Communication Magazine 2004, page 8
- [8] Rob Flickenger (others) 2007; Wireless networking in the developing world. Hacker Friendly LLC. 2nd edition. pp 4. pp55.
- [9] Garge, Vigay K. 2007; Wireless Communication and Networking, Elsevier Inc. pp 717,181,715, 671, 671, 662-663
- [10] IEEE 802.11a, "Wireless LAN Medium Access Control (MAC) and Physical Layer (PHY) specifications: High-speed Physical Layer in the 5 GHz Band," IEEE Std 802.11a-1999.
- [11] V.NAVI THEJESH1, "Performance Analysis of IEEE 802.11a WLAN Standard based on various Channels" PUBLICATIONS OF PROBLEMS & APPLICATION IN ENGINEERING RESEARCH – PA Vol 04, Issue03; May-June 2013.
- [12] Swati Sharma and Sanjeev Kumar, "BER Performance Evaluation of FFT-OFDM and DWT-OFDM", International Journal of Network and Mobile Technologies, ISSN 2229-9114 Electronic Version VOL 2 / ISSUE 2 / MAY 2011.
- [13] Cooley, James W.; Tukey, John W. (1965). "An algorithm for the machine calculation of complex Fourier series". Math. Comput. 19 (90): 297–301. doi:10.1090/S0025-5718-1965-0178586-1.
- [14] Krishna Kumar, Garima Saini, "Ber Performance Analysis of Daubechies Wavelet In Dvb-T For Rayleigh Channel, International Journal of Engineering Research & Technology, Vol.1 - Issue 10 (December - 2012)
- [15] van de Beek, J.-J & others, "A time and frequency synchronization scheme for multiuser OFDM", Selected Areas in Communications, IEEE Journal on, Year: 1999, Volume: 17, Issue: 11.
- [16] Sourabh Mahajan, Parveen Kumar ,Anita Suman, "Analysis of OFDM and OWDM System with various Wavelets Families", International Journal of Engineering Research and General Science Volume 2, Issue 3, April-May 2014
- [17] Khaizuran Abdullah and Zahir M. Hussain, "Simulation of Models and BER Performances of DWT-OFDM versus FFT-OFDM", Computer and Information Science » Numerical Analysis and Scientific Computing » "Discrete Wavelet Transforms - Algorithms and Applications", Chapter 4
- [18] Sulaiman M.Abbas Mohammed Nadhim Abbas Saifuldeen A.Mohammed, SLANTLET TRANSFORM-BASED OFDM SCHEME, Journal of Engineering, Number 3 Volume 13 September2006.
- [19] HAITHAM J. TAHA and M. F. M. Salleh "Multi-carrier Transmission Techniques for Wireless Communication Systems: A Survey", WSEAS TRANSACTIONS on COMMUNICATIONS, Issue 5, Volume 8, May 2009.
- [20] Dr. Saad N. Abdul Majed, MULTICARRIER CODE DIVISION MULTIPLE ACCESS BASED ON WAVELET", <http://www.iasj.net/iasj?func=fulltext&ald=51184>
- [21] Laith Ali Abdul-Rahaim; Hussein A. Lafta, "Scrambling based on 2D-Compersed Wavelet Transform and permutation Matrix in Communications Systems", JOURNAL OF TELECOMMUNICATIONS, VOLUME 15, ISSUE 2, AUGUST 2012.
- [22] <http://www.mathworks.com/help/wavelet/ref/orthfilt.html>
- [23] Savita, "BER Estimation: Mitigation Methods", International Journal of Computer Applications (0975 – 8887), Volume 48– No.25, June 2012

Eng. Habab H. Alshammary is a MSc holder in Electrical Communications from Mutah University- Jordan.

Dr. A. Al-Qawasmi is an associate professor at Majmaah University- Electrical Engineering Department. He received his Master PhD degrees from Kiev University of Civil Aviation Ukraine in 1999. He published more than 25 scientific papers in DSP and Wireless Communication systems. He was a Director of Computer center (2010-2011) and the head of Communications and Electronics department in Philadelphia University (2005-2010).